

**dancook**<sup>®</sup>  
danish gastronomic design







>> danish design made in denmark <<

**dancook**

>> designed with love for cooking <<  
dancook®





#### DANCOOK

The Danes have a long tradition for cooking outdoors. The beautiful nature in Denmark begs you to sit in front of a warming fire, enjoy the fine scents and the good company of friends and family.

Dancook is founded on this Danish tradition of cooking outdoors and we aim to create simple, high quality cookware for the best possible cooking results.

The history of Dancook dates back to 1992, when we began to develop functional and elegant quality barbecues. The unique products are manufactured in solid materials in a stylish, Danish design and ever since we have strived to develop our founding idea to perfection in close cooperation with our customers.

Dancook is a family owned company, and we manufacture the barbecues in Laurbjerg, Denmark.

#### DANCOOK

Danskere har en lang tradition for at tilberede mad udendørs. Danmarks smukke natur inviterer til at sætte sig omkring et varmende bål, nyde de fine dufte og samværet med andre mennesker.

Dancook bygger på denne danske tradition for madlavning i det fri - og for at skabe enkle, gedigne kvalitetsredskaber til den bedst mulige tilberedning.

Historien om Dancook går tilbage til 1992, hvor man begyndte med at udvikle funktionelle og elegante kvalitetsgrill. De unikke produkter blev fremstillet i stærke materialer i et stilrent, dansk design - og siden har vi hos Dancook videreudviklet vores grundide til perfektion i et tæt samarbejde med vores kunder.

Dancook er en familieejet virksomhed og grillene fremstilles i Laurbjerg - Danmark.

#### DANCOOK

Die Zubereitung von Speisen im Freien hat bei den Dänen eine lange Tradition. Die schöne Natur Dänemarks lädt geradezu dazu ein, sich um eine wärmende Feuerstelle zu setzen, die feinen Düfte und das Beisammensein mit Anderen zu genießen.

Dancook gründet sich auf diese dänische Tradition der Zubereitung von Speisen im Freien - und darauf, einfache, gediegene Qualitätsgeräte für eine bestmögliche Zubereitung zu entwickeln.

Die Geschichte von Dancook begann 1992 mit der Entwicklung funktioneller und eleganter Qualitätsgrills. Die außergewöhnlichen Produkte wurden aus solidem Material in stilechtem dänischen Design produziert - und seitdem haben wir bei Dancook gemeinsam mit unseren Kunden diese Grundidee bis zur Perfektion immer weiterentwickelt.

Dancook befindet sich in Familienbesitz, die Grills werden in Laurbjerg, Dänemark, produziert.

>> we design our products to last forever <<

**dancook**<sup>®</sup>



KETTLE BARBECUE

>> we think in all sizes - and in one unique shape <<  
**dancook®**







dancook 1400

Art. nr. 109 001

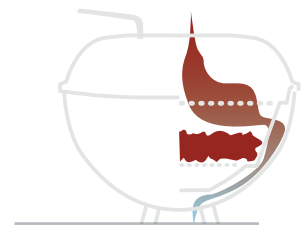

#### FUNCTION

The patented liner in Dancook's kettle-barbecue collect grease and ashes – and because the combustion air is pre-heated, the cooking effect is increased by 50%. The advantages are reduced use of briquettes and easier cleaning. That is the unique idea behind the Dancook kettlebarbecue.

#### FUNCTION

Den patenterede indsats i Dancook's kuglegrill opsamler fedtstof og aske - og fordi forbrændingsluften forvarmes forbedres grilleffekten med op til 50 %. Fordelene er nemmere rengøring og lavere kulforbrug. Den unikke idé bag Dancook kuglegrill.

#### FUNKTION

Der patentierte Einsatz in Dancooks Kugelgrill sammelt Fett und Asche - und weil die Verbrennungsluft vorgewärmt wird, verbessert sich der Grilleffekt um bis zu 50 %. Die Vorteile sind eine leichtere Reinigung und weniger Kohleverbrauch. Eine geniale Idee beim Kugelgrill von Dancook.

## dancook 1000



Art. nr. 109 000

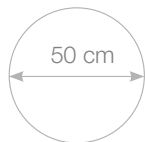

### DESIGN

A Dancook kettlebarbecue is best characterized by its simple design and its many unique details. The materials used are stainless steel and aluminium. The 6 mm grid and the many built in details guarantees optimal cooking results every time. In addition, Dancook supplies an extensive range of accessories.

## dancook 1600



Art. nr. 109 004



### DESIGN

Ein Kugelgrill von Dancook zeichnet sich durch sein einfaches Design und viele außergewöhnliche Details aus. Als Materialien werden Edelstahl und Aluminium verwendet. 6 mm starke Grillrost und viele integrierte Funktionen garantieren ein optimales Grillergebnis. Außerdem gibt es ein umfassendes Zubehör-Programm.

# dancook 1300



Art. nr. 109 008



## MOBILE

The new mobile kettlebarbecue from Dancook is extremely suitable for outdoor living, camping, the beach or balcony. The use is only limited by your imagination. The patented liner secures ashes and embers inside the barbecue and makes cleaning easier.

## MOBILITET

Den nye mobile kuglegrill fra Dancook er velegnet til friluftsliv, altanen, stranden..... Den patenterede indsats sikrer at aske og gløder bliver inde i grillen og gør den let at rengøre efter brug.

## MOBILITÄT

Der neue, mobile Kugelgrill von Dancook ist überall ideal: im Freien, auf dem Balkon, am Strand.... Durch den patentierten Einsatz bleiben Asche und Glut im Grill und so lässt er sich nach Gebrauch leicht reinigen.



dancook 1800



Art. nr. 109 502



dancook 1800 + sidetable



Sidetable  
Sidebord  
Seitliche Ablage  
- aluminium  
Art. nr. 120 121



dancook 1900



Art. nr. 109 500

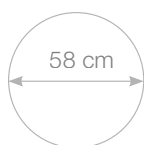

1800/1900

This new series of kettlebarbecues from Dancook are manufactured in a one piece frame which promises optimal stability and cooking ergonomics. The barbecue is "floating" in a ring of stainless steel. The barbecue can be extended with sidetable in massive aluminium. This magnificent series sets new standard for kettlebarbecues.

1800/1900

Den nye serie kuglegrill fra Dancook er fremstillet i ét smukt stel der sikrer optimal stabilitet og grillhøjde. Kuglegrillen svæver i en ring af rustfrit stål. Grillen kan udbygges med sidebord fremstillet i massiv aluminium. En ny serie der sætter nye standarder for kuglegrill.

1800/1900

Die neue Kugelgrill-Serie von Dancook hat ein ansprechendes Gestell, das optimale Stabilität und Grillhöhe garantiert. Der Kugelgrill schwebt in einem Ring aus Edelstahl. Mit einem Seitentisch aus massivem Aluminium ist der Grill erweiterbar. Eine neue Serie, die den Standard für Kugelgrills setzt.

## dancook 1500



Art. nr. 109 600

## accessories

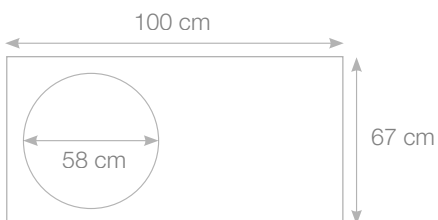

Carving board  
Skærebræt  
Schneidebrett

Art. nr. 120 126

1500/1501

Form and function reach new levels in Dancook's new kettlebarbecue. The simple and stylish design is underlined by the choice of materials – stainless steel and aluminium. The large worktop is ideal for preparing the barbecued dishes outside. This model comes with Dancook's 58 cm kettlebarbecue.

1500/1501

Form og funktion går op i en højere enhed i Dancook's nye grillvogn. De enkle og stilrene linier understreges af materialevalget - rustfrit stål og aluminium. Det store arbejdsbord er ideelt til at forberede grillmidagen udendørs. Leveres inkl. Dancook's 58 cm kuglegrill.

1500/1501

Im neuen Grillwagen von Dancook verbinden sich Form und Funktion zu einer noch edleren Einheit. Die einfachen, stيلةchten Linien werden durch das gewählte Material - Edelstahl und Aluminium - betont. Der große Arbeitstisch eignet sich perfekt zum Grillen unter freiem Himmel. Lieferung inkl. 58 cm Kugelgrill von Dancook.

dancook 1501



Art. nr. 109 601

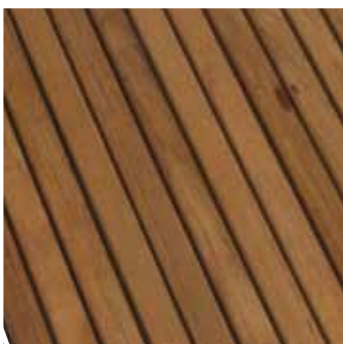
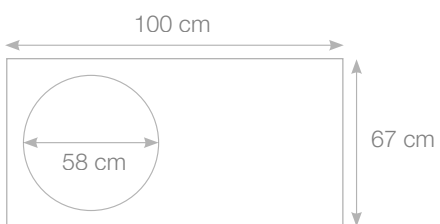

## dancook accessories

Handle  
Greb  
Griff  
- stainless steel  
Art. nr. 120 016



Grid  
Rist  
Rost  
Ø 45 cm - Dancook 1600, 1300  
Art. nr. 120 122

Ø 50 cm - Dancook 1000  
Art. nr. 120 013

Ø 58 cm - Dancook 1400, 1800, 1900, 1500, 1501, Kitchen, 9000  
Art. nr. 120 014

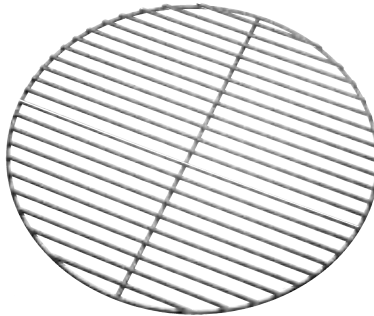

Pizzaplate  
Pizzapande  
Pizzaplatte  
Art. nr. 120 123



Cleaningtray  
Rensebakke  
Reinigungsbecken  
Art. nr. 120 124



Carving board  
Skærebrett  
Schneidebrett  
Art. nr. 120 126



Hooks  
Kroge  
Haken  
- stainless steel ( x 3 )  
Art. nr. 120 017



Warming rack  
Brødhylde  
Warmhalterost  
- stainless steel  
Art. nr. 120 019

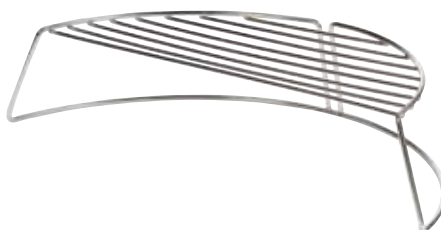

Charcoal divider  
Kulholder  
Holzkohle einteiler  
- stainless steel  
Art. nr. 120 015





# covers

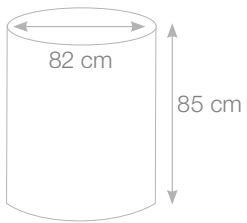

Dancook 1800  
Art. nr. 130 144

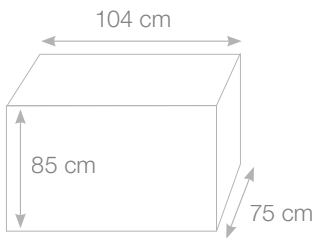

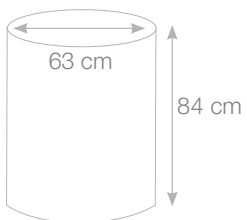

Dancook 1500,  
1900  
Art. nr. 130 138

Dancook 1400  
Art. nr. 130 143

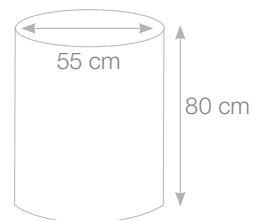

Dancook 1000,  
1600  
Art. nr. 130 139





>> we give people the feeling of freedom <<  
**dancook**<sup>®</sup>

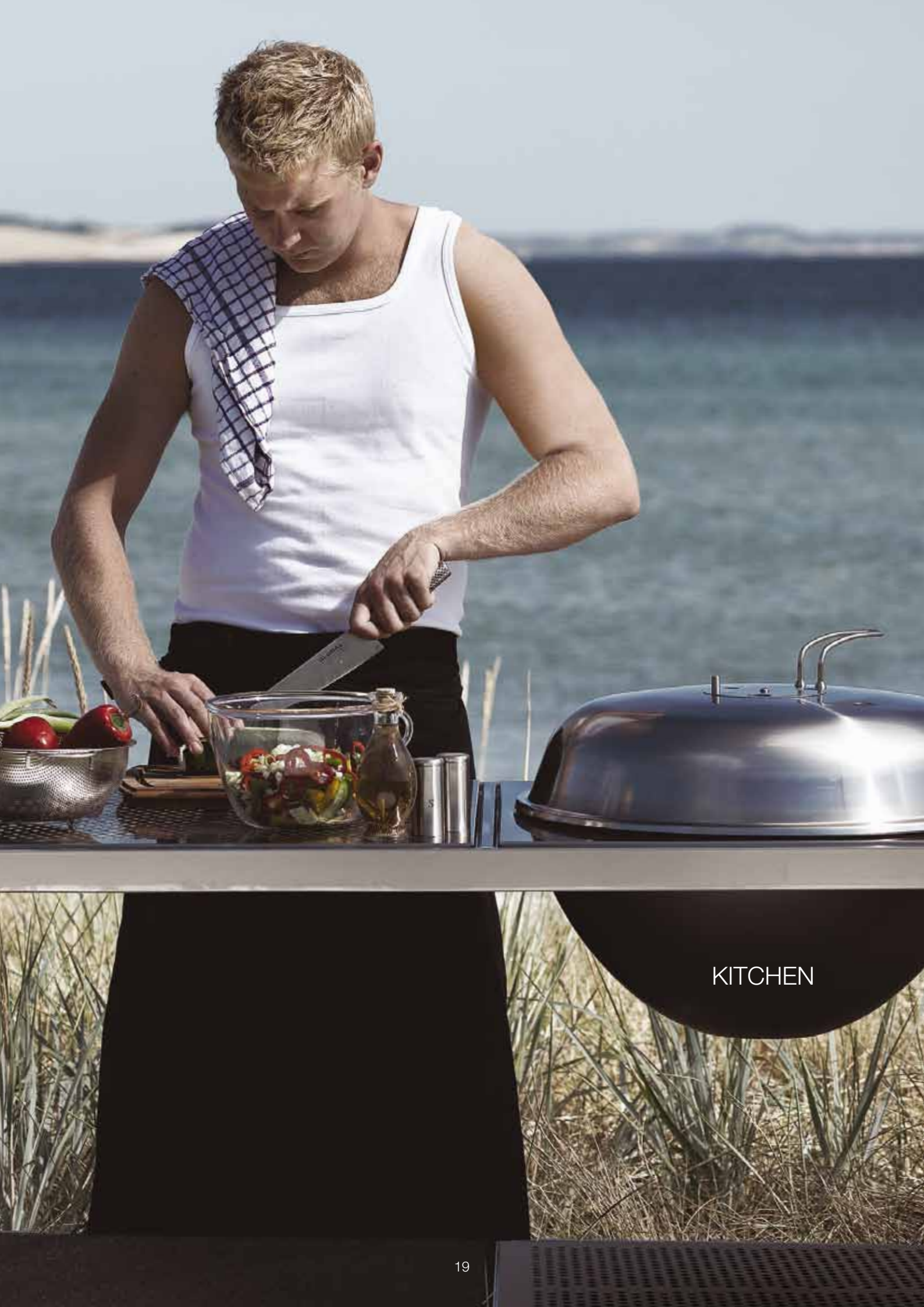

KITCHEN

## dancook kitchen



Art. nr. 170 100

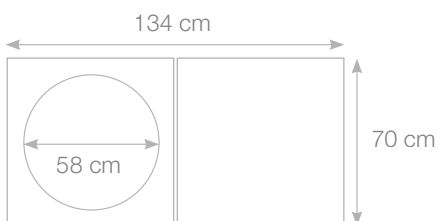

### KITCHEN

Dancook "Kitchen" is both a barbecue and a kitchen at the same time. The large table-top in granite (62x62cm) is ideal for preparing dinner before cooking. The simple and stylish design is underlined by the choice of materials – stainless steel and aluminium. This model is delivered with Dancook's 58 cm kettlebarbecue.

### KITCHEN

Dancook "Kitchen" er grill og køkken på samme tid. Den store bordplade i granit (62 x 62 cm) er ideel til at tilberede grillmidtdagen. De enkle og stilrene linier understreges af materialevalget - rustfrit stål og aluminium. Leveres inkl. Dancooks 58 cm kuglegrill.

### KITCHEN

Dancook "Kitchen" ist Grill und Küche in einem. Die große Granit Tischplatte (62 x 62 cm) ist zum vorarbeiten Ideal. Die einfachen, stillechten Linien werden durch das gewählte Material - Edelstahl und Aluminium - betont. Lieferung inkl. 58 cm Kugelgrill von Dancook.



**dancook<sup>®</sup>**

## dancook kitchen

Art. nr. 170 000

Art. nr. 170 004

Art. nr. 109 021

Art. nr. 170 001

Art. nr. 170 005

Art. nr. 170 003



Art. nr. 170 000

Art. nr. 170 003 (X2)

Art. nr. 170 001

Art. nr. 170 002



### BUILD YOUR OWN OUTDOOR KITCHEN

Individual design is the keyword for Dancook Kitchen. Start with the frame (art.no. 170000) and then choose what to place in the four squares. All modules are manufactured in weatherproof materials – granite, teak, or stainless steel.

### BYG DIT EGET UDEKØKKEN

Individuelt design er nøgleordet for dancook kitchen. Begynd med et stel (Art.nr. 170 000) og vælg derefter hvad der skal ligge i de fire felter. Alle moduler er fremstillet i vejrbestående materialer - granit, teak eller rustfrit stål.

### ENTWERFEN SIE IHRE PERSÖNLICHE FREILUFTKÜCHE

Individuelles Design ist das Schlüsselwort bei Dancook Kitchen. Starten Sie mit dem Gestell (Art.Nr. 170 000) und wählen Sie dann, was in den vier Feldern platziert werden soll. Alle Module sind aus wetterbeständigen Materialien hergestellt - Granit, Teak bzw. Edelstahl.

# kitchen accessories

Frame  
Stel  
Gestell  
Art. nr. 170 000



Cover  
Overtræk  
Wetterschutzhaube  
Art. nr. 170 200

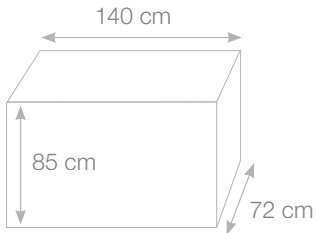

Kettlebarbecue  
Kugligrill  
Kugligrill  
Art. nr. 109 021



Table  
Bord  
Tisch  
- granite  
Art. nr. 170 001

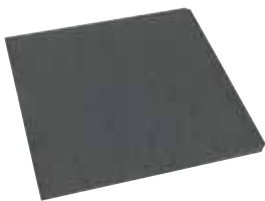

Table  
Bord  
Tisch  
- teak  
Art. nr. 170 003



Table for  
kettlebarbecue  
Bord til kugligrill  
Tisch für Kugligrill  
- stainless steel  
Ø 58 cm  
Art. nr. 170 004



Table for sink  
Bord til vask  
Tisch für Spüle  
- granit  
Art. nr. 170 002

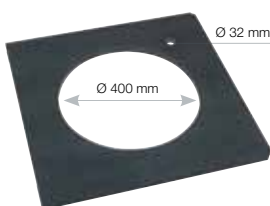

Grid  
Rist  
Rost  
- stainless steel  
Art. nr. 170 006



Table  
Bord  
Tisch  
- stainless steel  
Art. nr. 170 005

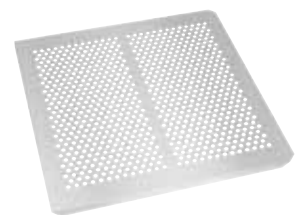

>> cooking on fire is feeling the nature <<

**dancook®**







FIREPLACE

## dancook 9000



Art. nr. 110 000



9000

The new bonfire from Dancook is a natural gathering point for the whole family. You can barbecue and have fireside cosiness all at the same time. You can use the bonfire with both wood and charcoal. The bonfire is very safe for children - Both due to height and because the edges of the bonfire do not get warm. The bonfire is made out of stainless steel. The cooking grid for the bonfire is made out of 6 mm chromium-plated steel, which makes for a better distribution of the heat. The bonfire is a cosier alternative to a terrace heater and is easy to move around.

9000

Det nye bålsted fra dancook er et naturligt samlingspunkt for hele familien. Her kan grilles og hygges på én gang. Bålstedet kan bruges med både brænde og kul. Bålstedet er meget børnevenligt - dels pga. højden og fordi bålstedets kanter ikke bliver varme. Fyrskålen er udført i rustfrit stål. Grillristen er udført i 6 mm forkromet stål, hvilket sikrer optimal varmfordeling. Bålstedet er et hyggeligt alternativ til en terrassevarmer og er nemt at flytte rundt.

9000

Der neue Feuerkorb von Dancook wird zum Lieblings-Treffpunkt für die ganze Familie. Hier wird gegrillt und man macht es sich gleichzeitig gemütlich. Für den Feuerkorb kann sowohl Brennholz als auch Kohle verwendet werden. Der Feuerkorb ist sehr kinderfreundlich - zum einen aufgrund seiner Höhe und weil die Kanten des Feuerkorbes nicht heiß werden. Der Feuerschale ist aus Edelstahl gefertigt. Das Grillrost auf dem Feuerkorb ist aus 6 mm starkem, verchromtem Stahl gefertigt, womit eine bessere Wärmeverteilung garantiert wird. Der Feuerkorb ist die gemütliche Alternative für den Terrassenofen und lässt sich leicht bewegen.



dancook 9000 accessories

Revolving holder  
Svingbar holder  
Schwenkbar Halter  
- stainless steel

Ø 53 cm  
Art. nr. 110 100



Sparkguard  
Gnistfang  
Funkenschutzhäube

Art. nr. 110 104



Lid  
Låg  
Deckel  
- stainless steel

Ø 72 cm  
Art. nr. 110 102



Cover  
Overtræk  
Wetterschutzhäube  
Art. nr. 110 103



Spit  
Spid  
Spieß  
- stainless steel

79 cm  
Art. nr. 120 018



Sidetable  
Sidebord  
Seitliche Ablage  
- aluminium

Art. nr. 120 121

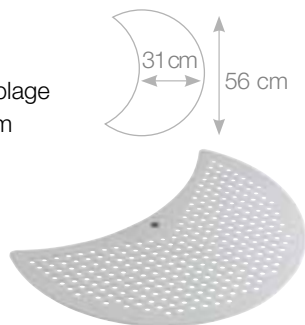

Barbecuepan  
Grillpande  
Grillpanne  
- stainless steel

Art. nr. 110 101





A close-up photograph of a black metal barbecue rack. The rack consists of several vertical bars with decorative, notched cutouts. A wooden handle is attached to the bottom of the rack. The background is a clear blue sky.

BOX BARBECUE

## dancook 4000



Art. nr. 107 621

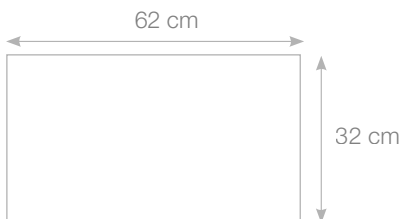

4000

Practical barbecue, and garden furniture in one. Produced in FSC certified hard wood with detachable cutting board. Flavour enhancing lid and hooks for accessories. Anthracite enamel with teflon - maintenance friendly surface. Heat resistant, aluminium coated, tray and back panel. Sturdy 6 mm chromium plated grid adjustable in four positions. Vertical barbecuing possible using spit and electric motor.

4000

Praktisk grill og havemøbel i ét. Fremstillet i FSC-certificeret hårdtræ, med aftageligt skærebræt. Aroma-forstærkende låg samt ophængskroge til tilbehør. Anthracitlakering med teflon - vedligeholdelsesvenlig overflade. Varmebestandig aluminiumsbelagt fyrkasse og bagplade. Kraftig 6 mm forkromet rist, der kan indstilles i 4 positioner. Mulighed for lodret grilning med spid og grillmotor.

4000

Praktischer Grill und Gartenmöbel in Einem. Hergestellt aus FSC-zertifiziertem Hartholz mit abnehmbarem Schneidebrett. Deckel zur Aromaverstärkung und Haken für Zubehör. Anthrazitlackierung mit Teflon - leicht zu reinigende Oberfläche. Hitzebeständige, feueraluminierte Feuerschale und Rückwand. 6 mm starker verchromter Rost (höhenverstellbar in 4 Positionen). Möglichkeit für senkrechtes Grillen mit Spieß und Grillmotor.

dancook

>> danish design made in denmark <<

**dancook®**





## dancook 5000



Art. nr. 102 623



5000

Double barbecue with 2 sidetables made of FSC certified hard wood. Anthracite enamel with teflon - maintenance friendly surface. Heat resistant, aluminium coated tray. Two sturdy, 6 mm chromium plated grids, adjustable in four positions. Vertical barbecuing possible using spit and electric motor.

5000

Dobbeltgrill med 2 sideborde fremstillet i FSC certificeret træ. Antracitlakering med teflon - vedligeholdelsesvenlig overflade. Varmebestandig aluminiumsbelagt fyrkasse. To kraftige 6 mm forkromede riste, der kan indstilles i 4 positioner. Mulighed for lodret grilning med spid og grillmotor.

5000

Doppelgrill mit 2 Seitenablagen aus FSC-zertifiziertem Hartholz. Anthrazitlackierung mit Teflon - leicht zu reinigende Oberfläche. Hitzebeständige, feueraluminierte Feuerschale. Zwei 6 mm starke Roste (höhenverstellbar in 4 Positionen). Möglichkeit für senkrechtes Grillen mit Spieß und Grillmotor.

# dancook 5600



Art. nr. 104 612



## 5600

Aroma increasing lid. 2 sidetables in FSC-certified hard wood. Anthracite enamel with teflon - maintenance friendly surface. Heat resistant, aluminium coated tray. Sturdy, 6 mm chromium plated grid, adjustable in four positions. Vertical barbecuing possible using spit and electric motor.

## 5600

Aromaforstærkende låg. 2 sideborde i FSC-certificeret hårdtræ. Antracitlakering med teflon - vedligeholdelsesvenlig overflade. Varmebeständig aluminiumsbelagt fyrkasse. Kraftige 6 mm forkromet rist, der kan indstilles i 4 positioner. Mulighed for lodret grilning med spid og grillmotor.

## 5600

Deckel zur Aromaverstärkung. 2 Seitenablagen aus FSC-zertifiziertem Hartholz. Anthrazitlackierung mit Teflon - leicht zu reinigende Oberfläche. Hitzebeständige, feuealuminierete Feuerschale. 6 mm starker Roste (höhenverstellbar in 4 Positionen). Möglichkeit für senkrechtes Grillen mit Spieß und Grillmotor.

Vertical barbecuing  
Lodret grilning  
Senkrechtes grillen



# dancook 5400



Art. nr. 104 503



5400

Detachable carving board in FSC certified hard wood. Anthracite enamel with teflon - maintenance friendly surface. Heat resistant, aluminium coated tray. Sturdy, 6 mm chromium plated grid, adjustable in four positions. Vertical barbecuing possible using spit and electric motor.

5400

Aftageligt skærebræt fremstillet i FSC certificeret hårdtræ. Antracitlakering med teflon - vedligeholdelsesvenlig overflade. Varmebestandig aluminiumsbelagt fyrkasse. Kraftigt 6 mm forkromet rist, der kan indstilles i 4 positioner. Mulighed for lodret grilning med spid og grillmotor.

5400

Abnehmbares Schneidebrett aus FSC-zertifiziertem Hartholz. Anthrazitlackierung mit Teflon - leicht zu reinigende Oberfläche. Hitzebeständige, feualuminierte Feuerschale. 6 mm starker Rost (höhenverstellbar in 4 Positionen). Möglichkeit für senkrechtes Grillen mit Spieß und Grillmotor.



# dancook 5100



Art. nr. 104 501

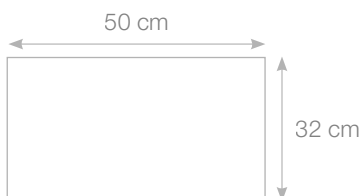

5100

Anthracite enamel with teflon - maintenance friendly surface. Heat resistant, aluminium coated tray. Sturdy, 6 mm chromium plated grid, adjustable in four positions. Vertical barbecuing possible using spit and electric motor.

5100

Antracitlakering med teflon - vedligeholdelsesvenlig overflade. Varmebestandig aluminiumsbelagt fyrkasse. Kraftig 6 mm forkromet rist, der kan indstilles i 4 positioner. Mulighed for lodret grilning med spid og grillmotor.

5100

Anthrazitlackierung mit Teflon - leicht zu reinigende Oberfläche. Hitzebeständige, feueraluminierete Feuerschale. 6 mm starker Rost (höhenverstellbar in 4 Positionen). Möglichkeit für senkrechtes Grillen mit Spieß und Grillmotor.



## dancook 5300



Art. nr. 104 611



5200/5300

2 sidetables made of FSC certified hard wood. Anthracite enamel with teflon - maintenance friendly surface. Heat resistant, aluminium coated tray. Sturdy, 6 mm chromium plated grid, adjustable in four positions. Vertical barbecuing possible using spit and electric motor.

5200/5300

2 sideborde fremstillet i FSC certificeret hårdtræ. Anthracitlakering med teflon - vedligeholdelsesvenlig overflade. Varmebestandig aluminiumsbelagt fyrkasse. Kraftig 6 mm forkromet rist, der kan indstilles i 4 positioner. Mulighed for lodret grilning med spid og grillmotor.

5200/5300

2 Seitenablagen aus FSC-zertifiziertem Hartholz. Anthrazitlackierung mit Teflon - leicht zu reinigende Oberfläche. Hitzebeständige, feueraluminierte Feuerschale. 6 mm starker Rost (höhenverstellbar in 4 Positionen). Möglichkeit für senkrechtes Grillen mit Spieß und Grillmotor.



Art. nr. 104 511

## dancook 5200



## dancook 7100



Art. nr. 101 501



7000/7100

Anthracite enamel with teflon - maintenance friendly surface. Heat resistant, aluminium coated tray. Sturdy, 6 mm chromium plated grid, adjustable in four positions. Vertical barbecuing possible using spit and electric motor.

7000/7100

Antracitlakering med teflon - vedligeholdelsesvenlig overflade. Varmebestandig aluminiumsbelagt fyrkasse. Kraftig 6 mm forkromet rist, der kan indstilles i 4 positioner. Mulighed for lodret grilning med spid og grillmotor.

7000/7100

Anthrazitlackierung mit Teflon - leicht zu reinigende Oberfläche. Hitzebeständige, feueraluminiumierte Feuerschale. 6 mm starker Roste (höhenverstellbar in 4 Positionen). Möglichkeit für senkrechtes Grillen mit Spieß und Grillmotor.



Art. nr. 101 422

## dancook 7000

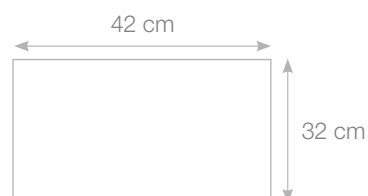

## dancook 7400



Art. nr. 101 621

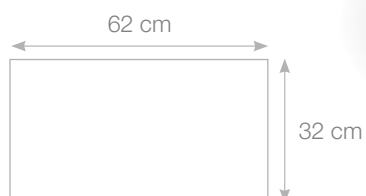

7200/7400

Anthracite enamel with teflon - maintenance friendly surface. Heat resistant, aluminium coated tray. Sturdy, 6 mm chromium plated grid, adjustable in four positions. Vertical barbecuing possible using spit and electric motor.

7200/7400

Antracitlakering med teflon - vedligeholdelsesvenlig overflade. Varmebestandig aluminiumsbelagt fyrkasse. Kraftig 6 mm forkromet rist, der kan indstilles i 4 positioner. Mulighed for lodret grilning med spid og grillmotor.

7200/7400

Anthrazitlackierung mit Teflon - leicht zu reinigende Oberfläche. Hitzebeständige, feueraluminierter Feuerschale. 6 mm starker Rost (höhenverstellbar in 4 Positionen). Möglichkeit für senkrecht Grillen mit Spieß und Grillmotor.



## dancook 7200

Art. nr. 101 502

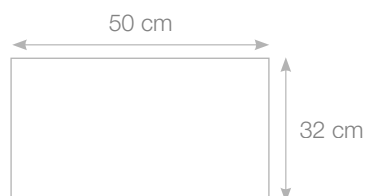

## dancook 7500



Art. nr. 101 626

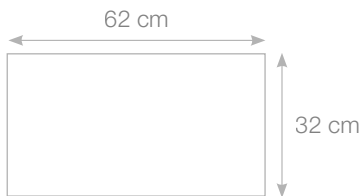

7300/7500

2 sidetables made of FSC certified hard wood. Anthracite enamel with teflon - maintenance friendly surface. Heat resistant, aluminium coated tray. Sturdy, 6 mm chromium plated grid, adjustable in four positions. Vertical barbecuing possible using spit and electric motor.

7300/7500

2 sideborde fremstillet i FSC certificeret hårdtræ. Antracitlakering med teflon - vedligeholdelsesvenlig overflade. Varmebestandig aluminiumsbelagt fyrkasse. Kraftig 6 mm forkromet rist, der kan indstilles i 4 positioner. Mulighed for lodret grilning med spid og grillmotor.

7300/7500

2 Seitenablagen aus FSC-zertifiziertem Hartholz. Anthrazitlackierung mit Teflon - leicht zu reinigende Oberfläche. Hitzebeständige, feuraluminierte Feuerschale. 6 mm starker Rost (höhenverstellbar in 4 Positionen). Möglichkeit für senkrechtes Grillen mit Spieß und Grillmotor.



Art. nr. 101 507

## dancook 7300

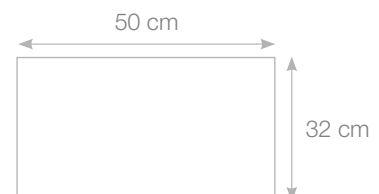



# dancook 8100



Art. nr. 106 421

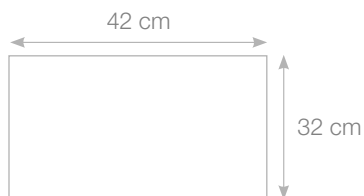

8100

The mobile barbecue, which you can bring along everywhere. Suitable for leisure activities, going to the beach, or just for a meal on the balcony... Anthracite enamel with teflon - maintenance friendly surface. Heat resistant, aluminium coated tray. Sturdy, 6 mm chromium plated grid, adjustable in four positions. Vertical barbecuing possible using spit and electric motor.

Vertical barbecuing  
Lodret grilning  
Senkrechtes grillen

8100

Praktisk grill, nærmest til at ta' under armen. Velegnet til friluftsliv, altanen, stranden... Antracitlakering med teflon - vedligeholdelsesvenlig overflade. Varmebestandig aluminiumsbelagt fyrkasse. Kraftig 6 mm forkromet rist, der kan indstilles i 4 positioner. Mulighed for lodret grilning med spid og grillmotor.

8100

Grillgerät für Unterwegs. Perfekt für Freizeit, Balkon oder Strand... Anthrazitlackierung mit Teflon - leicht zu reinigende Oberfläche. Hitzebeständige, feuealuminiumierte Feuerschale. 6 mm starker Rost (höhenverstellbar in 4 Positionen). Möglichkeit für senkrechtes Grillen mit Spieß und Grillmotor.



## covers

5100, 7000, 7100 & 7200  
Art. nr. 130 124

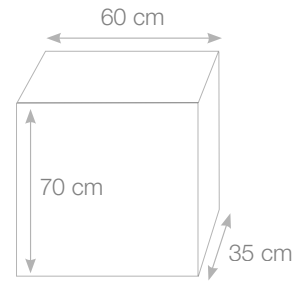

5200, 5300, 5400, 5600,  
7300, 7400 & 7500  
Art. nr. 130 125

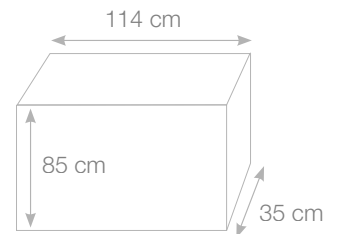

4000 & 5000  
Art. nr. 130 138

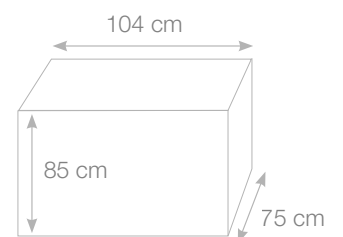

# dancook accessories

Grid  
Rist  
Rost

Art. nr. 120 003 - 40 x 40 cm  
Art. nr. 120 004 - 40 x 60 cm

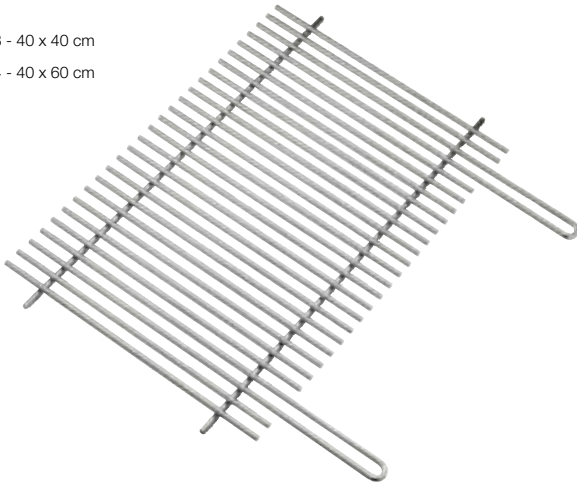

Charcoaltray  
Kulkasse  
Kohlenschale



Dancook 7000, 8100

Art. nr. 120 130 - 25 x 39 cm

Dancook 7100, 7200, 7300, 5100,  
5200, 5400

Art. nr. 120 131 - 25 x 47 cm

Dancook 7400, 7500, 4000, 5300,  
5600, 5000

Art. nr. 120 132 - 25 x 60 cm



Grid  
Rist  
Rost

Dancook 7000, 8100

Art. nr. 120 010 - 42 cm

Dancook 7100,  
7200, 7300, 5100,  
5200, 5400

Art. nr. 120 011 - 50 cm

Dancook 7400,  
7500, 4000, 5300,  
5600, 5000

Art. nr. 120 012 - 62 cm



Barbecuespit  
Grillspid  
Grillspieß

Art. nr. 130 105 - 42 & 50 cm

Art. nr. 130 106 - 62 cm



Barbecuemotor

Grillmotor

Grillmotor

1,5 V

Art. nr. 130 110



Universalsshelf  
Universalshylde  
Mehrzweckablage

Art. nr. 130 120



Meatforks  
Spidgafler  
Fleischklammer

Art. nr. 130 107



Barbecuemotor

Grillmotor

Grillmotor

230 V

Art. nr. 130 111





>> we design our products to last forever <<  
**dancook**<sup>®</sup>

GASBARBECUE

## dancook 6000



DK - Art. nr. 140 901

DE - Art. Nr. 140 906



6000

Gas barbecue for the gourmets.

4 burners ensure uniform heat distribution as well as the "true" barbecue flavor of the food. Made with a tilting lid, allowing the chef to monitor the cooking process. The heat is easily distributed and adjusted using knobs and the barbecue is easily ignited by a simple push. Detachable grease tray, to make cleaning quick and easy. 4 burners in stainless steel (14,0 KW) and a side burner (4,5 KW). Made from stainless steel and anthracite coated steel.

6000

Gasgrill for gourmet'er.

4 brændere sikrer ensartet varmefordeling og den "rigtige" grillsmag. Udført med vippe-låg og termometer, så kokken hele tiden kan følge med. Varmen reguleres let ved hjælp af drejeknapper og tændes med et enkelt tryk. Udtagelig drypbakke der gør rengøringen meget lettere. 4 brændere i rustfrit stål (14,0 KW) og sidebrænder (4,5 KW). Fremstillet i rustfrit stål og antracitlakeret stål.

6000

Der Gasgrill für Gourmets.

4 Brenner gewährleisten eine gleichmäßige Wärmeverteilung und liefern den „echten“ Grillgeschmack. Der dancook 6000 ist mit Klappdeckel und Thermometer ausgestattet – so hat der der Grillmeister immer alles im Griff. Die Hitzefuhr lässt sich mit Drehknöpfen ganz leicht regulieren und das Zünden erfolgt per Druckknopf. Einfache Reinigung durch herausnehmbare Abtropfschalen. 4 Brenner aus Edelstahl (14,0 kW), ein Seitenbrenner (4,5 kW). Hergestellt aus rostfreiem Stahl und lackiertem Stahl, Farbe: Anthrazit.

# dancook 6001



DK - Art. nr. 140 902

DE - Art. Nr. 140 907

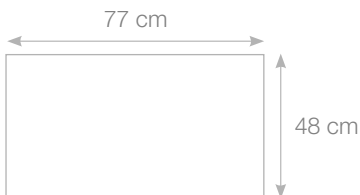

## 6001

Gas barbecue for the gourmets.

5 burners ensure uniform heat distribution as well as the "true" barbecue flavor of the food. Made with a tilting lid, allowing the chef to monitor the cooking process. The heat is easily distributed and adjusted using knobs and the barbecue is easily ignited by a simple push. Detachable grease tray, to make cleaning quick and easy. 5 burners in stainless steel (18,5 KW) and a side burner (4,5 KW). Made from stainless steel and anthracite coated steel.

## 6001

Gasgrill for gourmet'er.

5 brændere sikrer ensartet varmefordeling og den "rigtige" grillsmag. Udført med vippe-låg og termometer, så kokken hele tiden kan følge med. Varmen reguleres let ved hjælp af drejeknapper og tændes med et enkelt tryk. Udtagelig drypbakke der gør rengøringen meget lettere. 5 brændere i rustfrit stål (18,5 KW) og sidebrænder (4,5 KW). Fremstillet i rustfrit stål og antracitlakeret stål.

## 6001

Der Gasgrill für Gourmets.

5 Brenner gewährleisten eine gleichmäßige Wärmeverteilung und liefern den „echten“ Grillgeschmack. Der dancook 6000 ist mit Klappdeckel und Thermometer ausgestattet – so hat der der Grillmeister immer alles im Griff. Die Hitzezufuhr lässt sich mit Drehknöpfen ganz leicht regulieren und das Zünden erfolgt per Druckknopf. Einfache Reinigung durch herausnehmbare Abtropfschalen. 5 Brenner aus Edelstahl (18,5 kW), ein Seitenbrenner (4,5 kW). Hergestellt aus rostfreiem Stahl und lackiertem Stahl, Farbe: Anthrazit.

## dancook accessories

Cast iron plate - Reversible  
Støbejernsplade - Vendbar  
Gusseisenplatte - Wendbar

Art. nr. 140 952



Rotisserie  
Spid  
Drehspieße  
Dancook 6000, 6001

Art. nr. 140 953



Cover Dancook 6000, 6100

Art. nr. 170 200



Lavarocks  
Lavasten  
Lavasteine

Art. nr. 140 501



Cover gas cylinder  
Overtræk gasflaske  
Wetterschutzhaube  
Gasbehälter

Art. nr. 140 504



Regulator  
med slange

Art. nr. 140 503



## dancook accessories

Shish kebab spits  
Kebabspid  
Kebabspiese

Art. nr. 130 103



Shish kebab set  
Kebabsæt  
Kebabset

Art. nr. 130 104

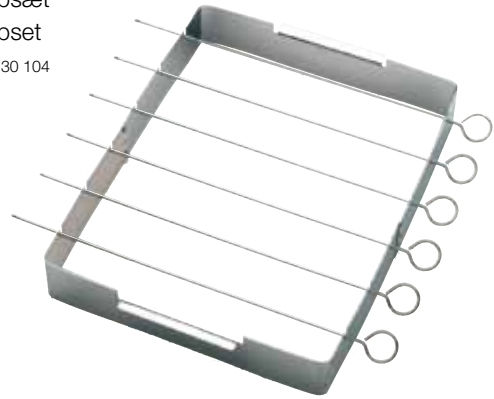

3 pcs. barbecueset  
3 dele grillbestik  
3 Teile Grillbesteck

Art. nr. 130 114



Tong  
Tang  
Zange

Art. nr. 130 101



3 pcs. barbecueset  
3 dele grillbestik  
3 Teile Grillbesteck

- stainless steel

Art. nr. 130 154



Tong  
Tang  
Zange  
- stainless steel

Art. nr. 130 150



Fork  
Gaffel  
Gabel  
- stainless steel

Art. nr. 130 152

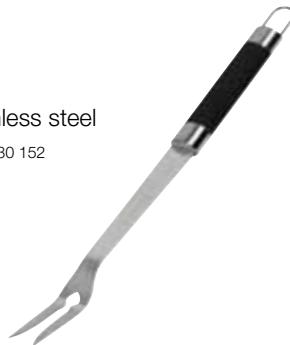

Turner  
Spatel  
Wender  
- stainless steel

Art. nr. 130 153



Cleaning brush  
Grillbørste  
Grillbürste  
- stainless steel

Art. nr. 130 151



Cleaning brush  
Grillbørste  
Grillbürste

Art. nr. 130 202



Handle  
Greb  
Griff  
- stainless steel

Art. nr. 120 016





# dancook accessories

Barbecue broiler  
Bøfvender  
Fleischwender  
- non stick  
Art. nr. 130 117



Fish broiler  
Fiskevender  
Fischwender  
- non stick  
Art. nr. 130 119

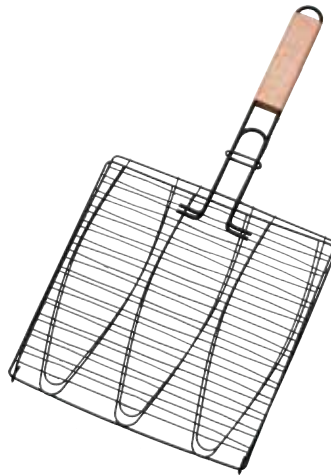

Barbecue broiler  
Bøfvender  
Fleischwender  
Art. nr. 130 116



5 pcs. barbecue pans  
5 stk. alubakker  
5 St. Alugrillphannen  
Art. nr. 130 137



Barbecue mitten  
Grillhandske  
Grillhandsuh  
Art. nr. 130 113



Fish broiler  
Fiskevender  
Fischwender  
Art. nr. 130 118

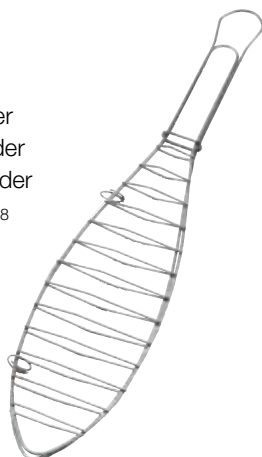

Smoking powder  
Røgesmuld  
Räuchermehl  
Art. nr. 120 002





>> we give people the feeling of freedom <<

**dancook®**

# dancook accessories

Barbecue starter  
Grillstarter  
Anzündkamin

· 2,5 kg  
Art. nr. 120 000



Electric barbecue starter  
Elstarter  
Elektro Grillanzünder

Art. nr. 130 122

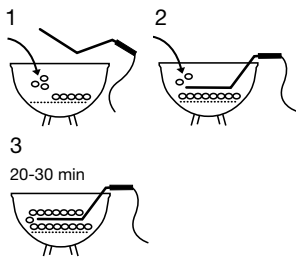

Charcoal  
Grillkul  
Holzkohle

· 2,5 kg  
· 31.000 KJ  
Art. nr. 130 131



Briquets  
Briketter  
Briketts

· 10 kg  
· 29.000 KJ  
Art. nr. 130 134



Lighting fluid  
Tændvæske  
Flüssig

· 1000 ml  
Art. nr. 130 129



Briquets  
Briketter  
Briketts

· 2,5 kg  
· 29.000 KJ  
Art. nr. 130 132



Paraffin  
Paraffin  
Paraffin

Art. nr. 130 128



Instant barbecue  
Engangsgrill  
Einweggrill

Art. nr. 130 126



**dancook**<sup>®</sup>  
danish gastronomic design

Kriswell A/S  
Knudstrupvej 10 C, Laurbjerg  
DK - 8870 Langaa  
Tel. +45 87 73 60 00  
Fax. +45 87 73 60 09  
info@dancook.dk  
www.dancook.dk

